

Kern- / Gesamtdicke: 60 / 98

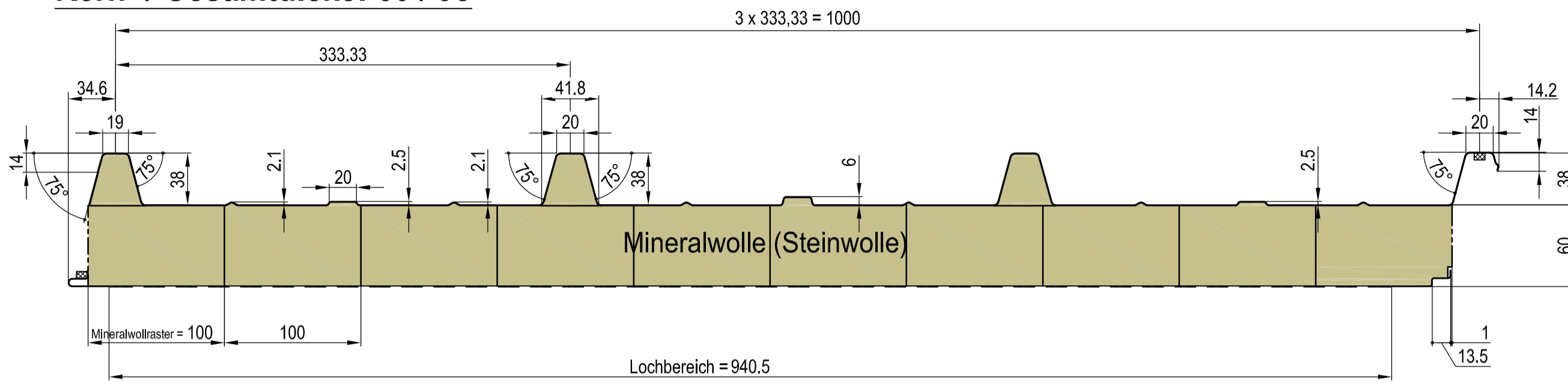

Kern- / Gesamtdicke: 80 / 118

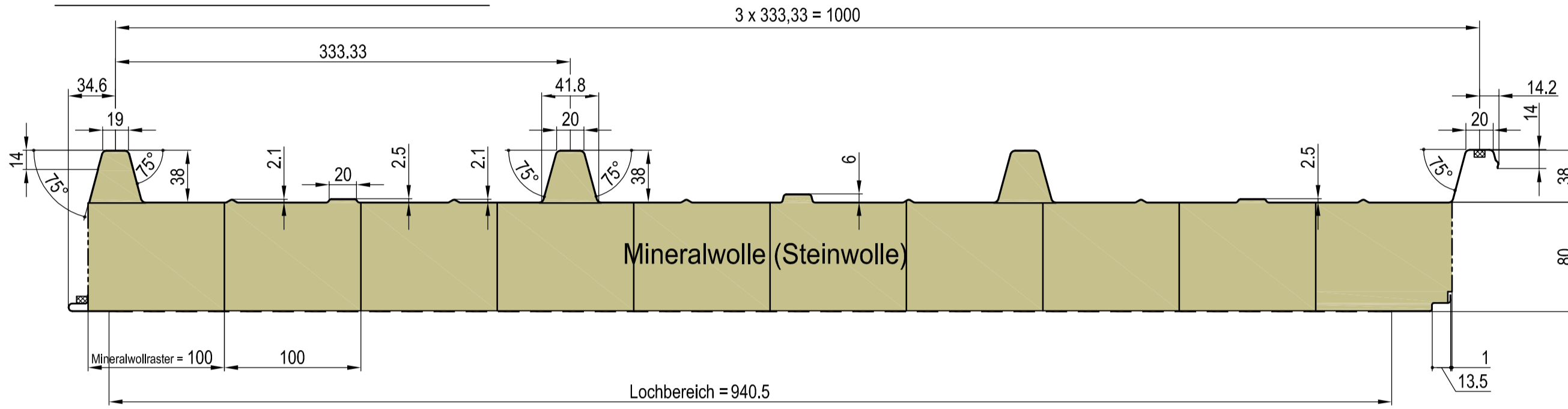

Kern- / Gesamtdicke: 100 / 138

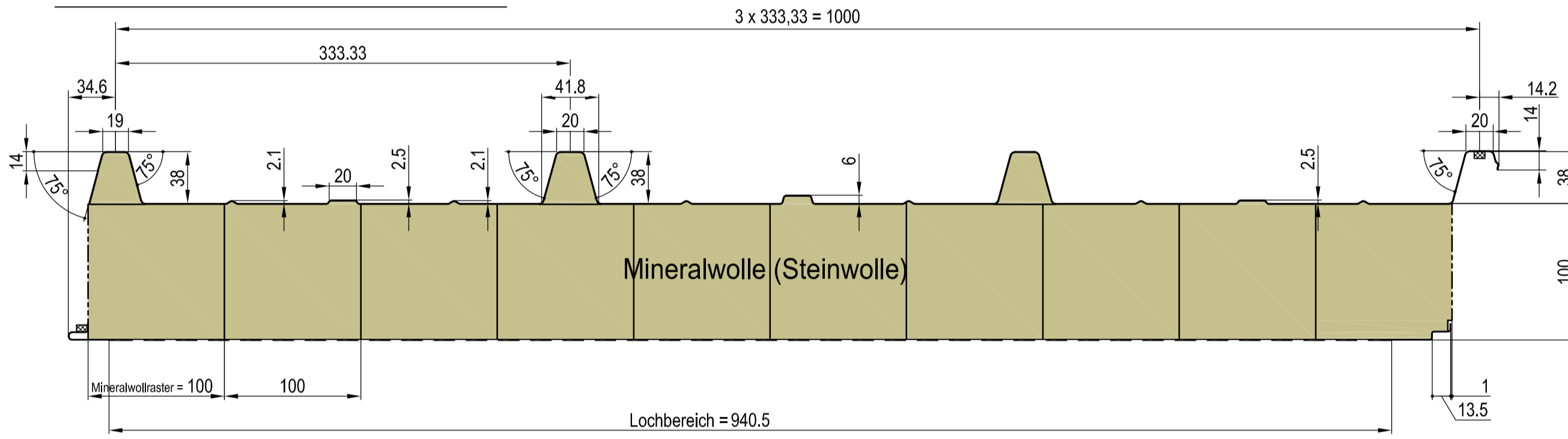

Kern- / Gesamtdicke: 120 / 158

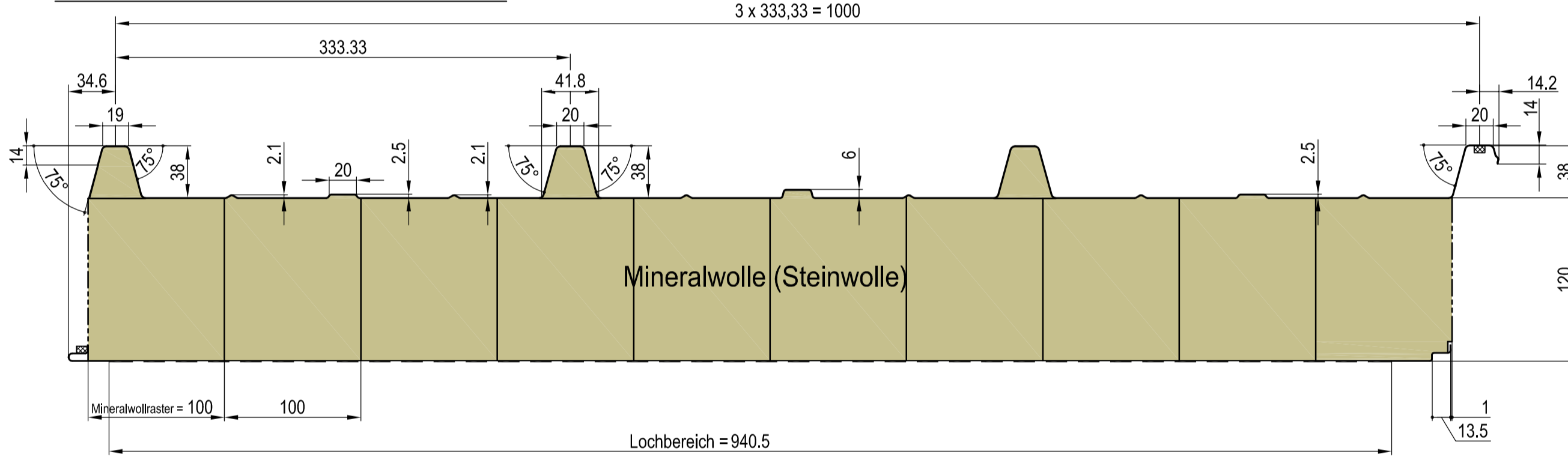

Kern- / Gesamtdicke: 150 / 188

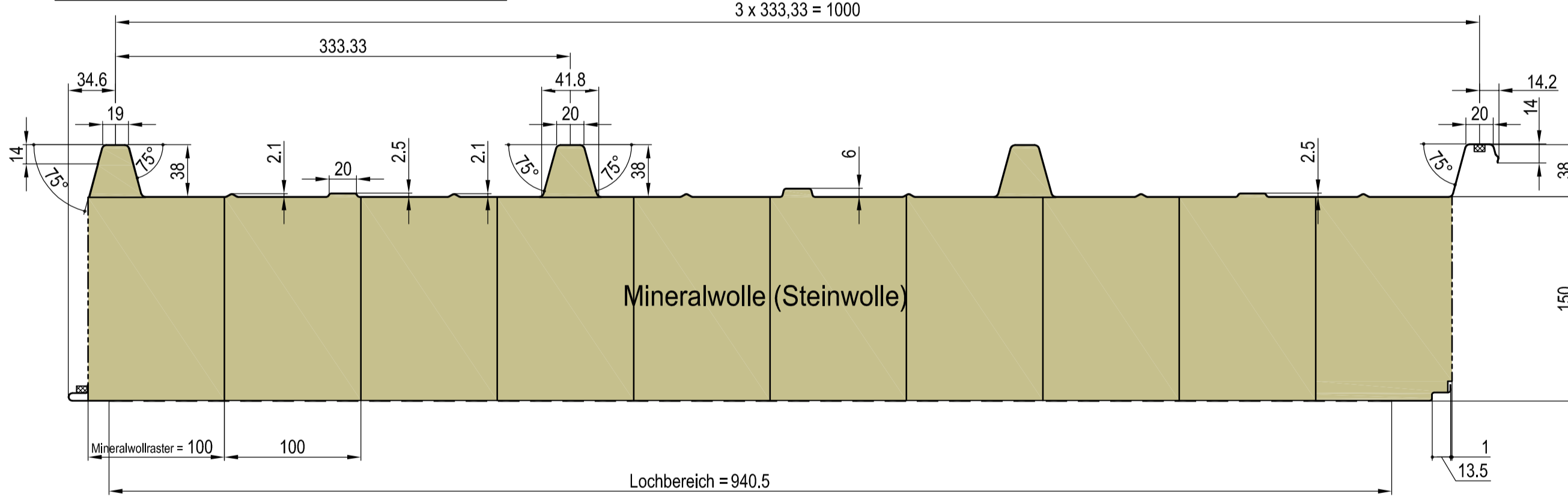

Kern- / Gesamtdicke: 200 / 238

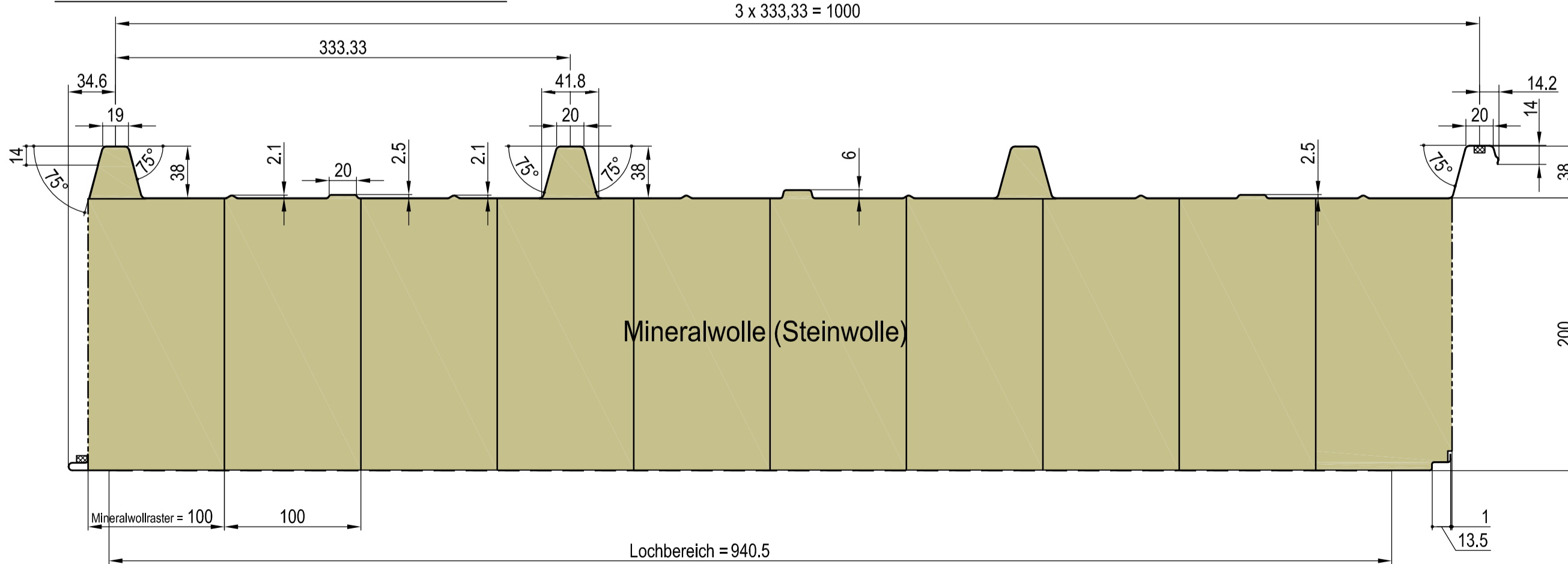

Detail Hochsicke

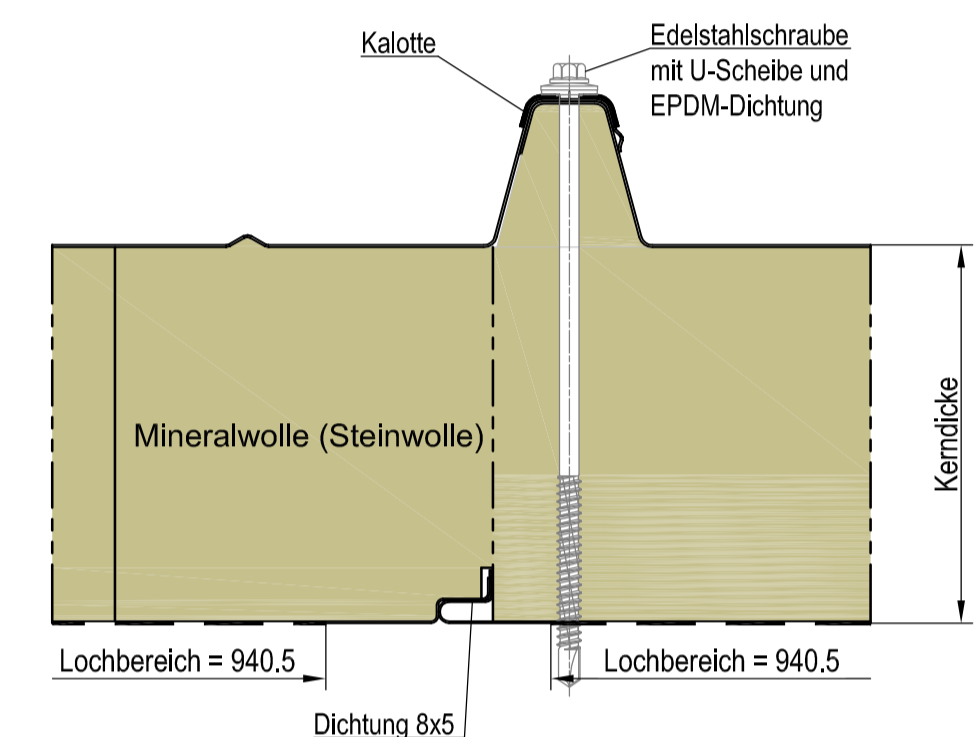

Detail Tiefsicke

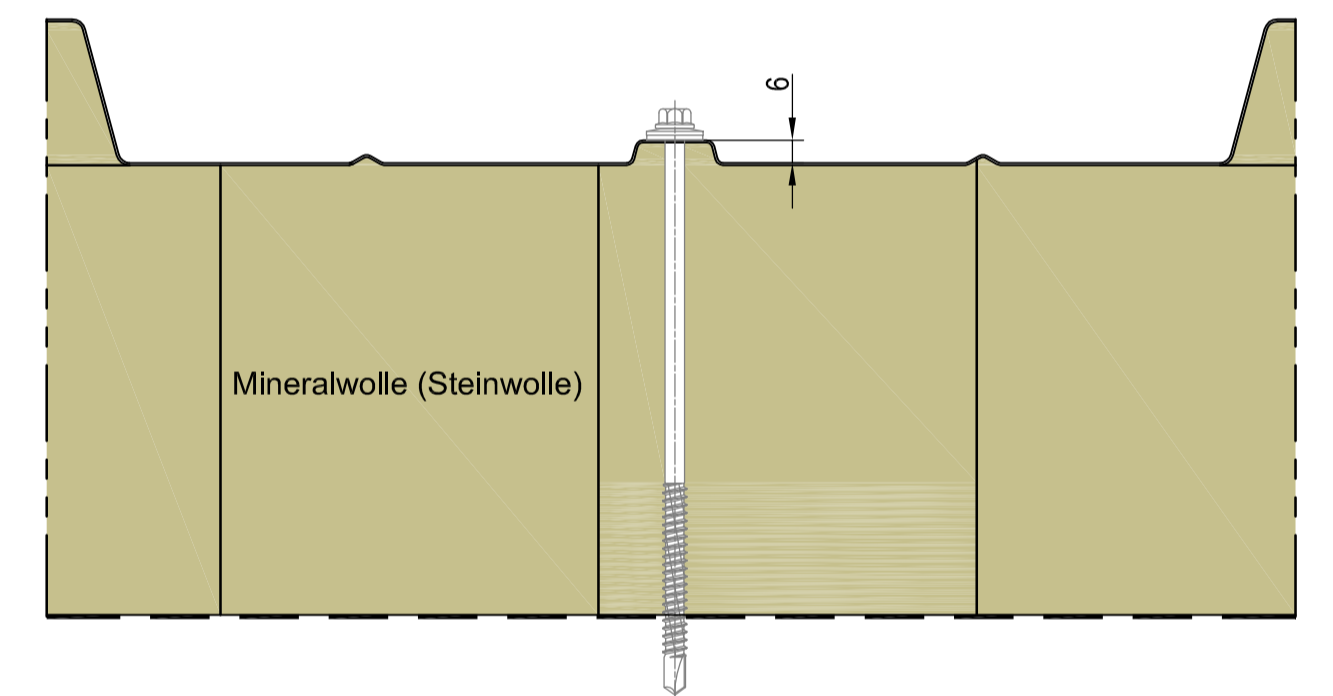

Detail Lochbild

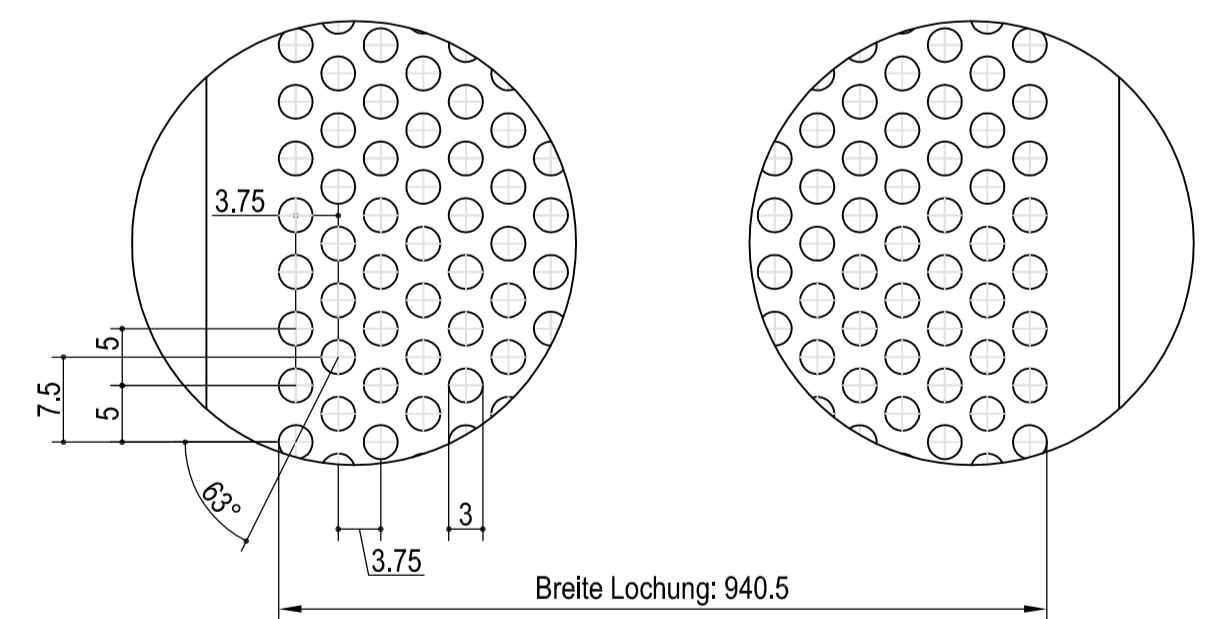

Eben gelocht - PL-000

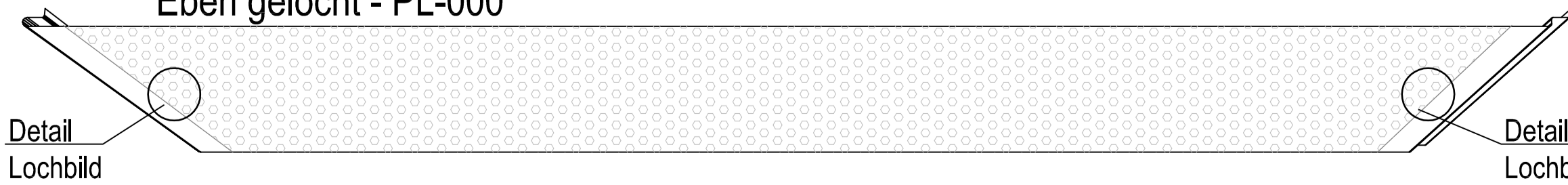

Es gelten die Toleranzen gemäß DIN EN 14506.

Metecno Baustysteme GmbH		Material	o. M.	Position	Menge
Am Amselberg 1					
99444 Blankenhain		Zeichnungs-Nr. 03-A			
Bearb.	17.03.14	Name	Hipertec - Dach - Sound		
Zeich.	17.03.14	ZB Cramer	Sandwich - Dachelement mit Dämmkern aus		
Norm		Fr. Graf	Mineralwolle (Steinwolle)		
Zust. Sachbearbeiter:		R. Bräunel	HTDS		
Metecno Baustysteme GmbH					
Zust.	Änderung	Datum	Name		